



**LOGIC**  
TECHNOLOGIES

## PRODUCT SPECIFICATION

### DESCRIPTION

TFT Module – 4.3”  
480 x (RGB) x 272

### PART NUMBER

LTDD480272043-L2-HB

### VERSION

1.0

ROHS COMPLIANT



## Table of Contents

- GENERAL INFORMATION
- MECHANICAL DIMENSIONS
- ABSOLUTE MAXIMUM RATINGS
- ELECTRICAL CHARACTERISTICS
- BACKLIGHT CHARACTERISTICS
- ELECTRO-OPTICAL CHARACTERISTICS
- INTERFACE DESCRIPTION
- TIMING CHART & DATA
- APPLICATION NOTE
- RELIABILITY TESTING
- INSPECTION CRITERIA
- INSPECTION STANDARD
- PRECAUTIONS FOR USING LCD MODULES

- GENERAL INFORMATION

Item	Contents	Unit
LCD Type	TFT Transmissive	/
Technology	a-Si TFT	-
Viewing Direction	12:00	O'clock
Viewing Angle (Gray Scale Inversion Direction)	6:00	O'clock
Module dimensions (W x H x T)	105.5x 67.2 x 2.90	mm
Active area (W x H)	95.04 x 53.86	mm
Number of pixels	480 x 3 (RGB) x 272	/
Pixel pitch (W x H)	0.198 x 0.198	mm <sup>2</sup>
Colours	16 M/262k	/
Contrast ratio	500 (typical)	/
Backlight	LED	/
Backlight Brightness	600	cd/m <sup>2</sup>
Interface	24-bit RGB interface	/
Operating temperature	-20 to +70	°C
Storage temperature	-30 to +80	°C

MECHANICAL DIMENSIONS

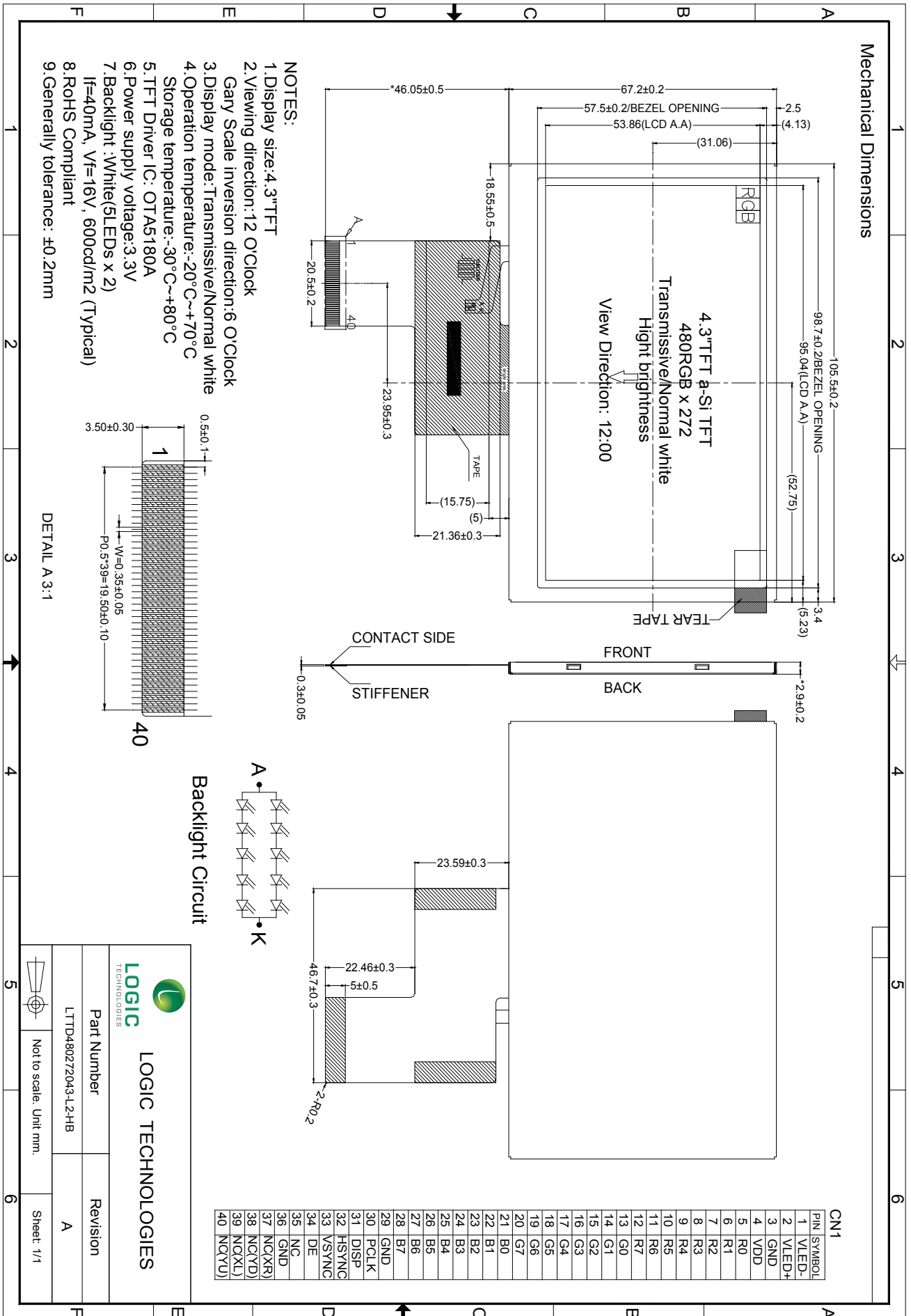

**LOGIC TECHNOLOGIES**

Part Number: LTTD480272043-L2-HB

Revision: A

Not to scale. Unit mm.

Sheet: 1/1

- ABSOLUTE MAXIMUM RATING

Parameter	Symbol	Min.	Max.	Unit	Note
Power Voltage	$V_{DD}$	- 0.3	4.0	V	
Back Light Forward Current	$I_{LED}$		25	mA	For each LED
Operating Temperature	$T_{OPR}$	- 20	70	°C	
Storage temperature	$T_{ST}$	- 30	80	°C	

- ELECTRICAL CHARACTERISTICS

Parameter	Symbol	Min	Typ.	Max	Unit	Remark
Supply Voltage	$V_{DD}$	3.0	3.3	3.6	V	
VDD Power Consumption	$I_{DD}$	--	22	---	mA	Note 2
Input Signal Voltage	VIL	0	---	0.3xVDD	V	R0-R7, G0-G7, B0-B7, DE, DCLK, HSD, VSD, MODE, RSTB, STBY, SHLR, UPDN, VCOM, DITH, V1-V10
	VIH	0.7xVDD	---	VDD	V	
Output Signal Voltage	VOL	0	---	0.2xVDD	V	
	VOH	0.8xVDD	---	VDD	V	
Power Consumption	Panel and Gamma		72.6	--	mW	
	Backlight		640	--	mW	
	Total		713	---	mW	

Note: The current dissipation is tested with "all Black Pattern".

- BACKLIGHT CHARACTERISTICS

Item	Symbol	Min.	Typ.	Max.	Unit	Condition
Forward Current	$I_F$	---	40	25	mA	Note 1
Forward Current Voltage	$V_F$	---	16	17	V	Note 2
Backlight Power Consumption	$W_{BL}$	---	640	---	mW	Note 1
LED Lifetime	---	----	25000	---	Hrs	Note 3

Note 1: The LED driving condition is defined for total backlight consumption.

Note 2: Forward Voltage adjusting should depend on Forward Current setting.

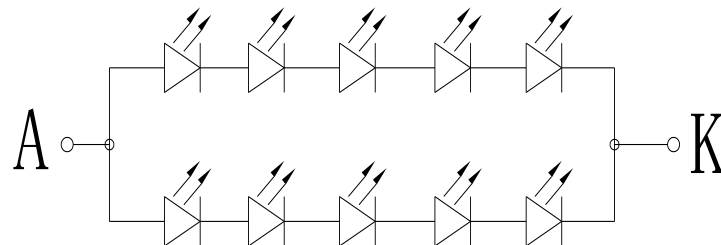

Note 3 :  $I_F$  is defined for one channel LED.

Optical performance should be evaluated at  $T_a=25^\circ\text{C}$  only.

If the LEDs are driven by high current, high ambient temperature & humidity condition the lifetime of the LEDs will be reduced.

Operating life means brightness reduces to 50% of initial brightness.

Typical operating life time is estimated data.

Backlight drive conditions : constant current driving method.

## • ELECTRO-OPTICAL CHARACTERISTICS

Item	Symbol	Condition	Min.	Typ.	Max.	Unit	Refer	Note	
Response Time	$T_{ON}$	$25^\circ\text{C}$	---	10	15	Ms	Fig 1	1	
	$T_{OFF}$		---	15	20				
Contrast ratio	Cr	$\theta = 0^\circ$	400	500	---	---	Fig 2	1	
Uniformity	U	---	---	75	---	%	Fig 2	3	
Surface Luminance	$L_v$		500	600	---	$\text{cd/m}^2$	Fig 2	2	
Viewing angle ratio	$\theta$	$\varnothing = 90^\circ$	45	55	---	---	Fig 3	6	
		$\varnothing = 270^\circ$	60	70	---				
		$\varnothing = 0^\circ$	60	70	---				
		$\varnothing = 180^\circ$	60	70	---				
CIE (x,y) chromaticity	Red	x	Backlight On	0.559	0.609	0.659	---	Fig 2.	5
		y		0.305	0.355	0.405			
	Green	x		0.277	0.315	0.364			
		y		0.505	0.555	0.605			
	Blue	x		0.089	0.136	0.189			
		y		0.089	0.139	0.189			
	White	x		0.254	0.304	0.354			
		y		0.294	0.344	0.394			

## Note

1. Contrast ratio (CR) is defined mathematically in Figure 2.

$$\text{Contrast Ratio} = \frac{\text{Average Surface Luminance with all white pixels (P1, P2, P3, P4, P5)}}{\text{Average Surface Luminance with all black pixels (P1, P2, P3, P4, P5)}}$$

Note 2. Surface luminance is the LCD surface from the surface with all pixels displaying white. For more information see figure 2.

$$L_v = \text{Average Surface Luminance with all white pixels (P1, P2, P3, P4, P5...)}$$

Note 3. Uniformity of surface luminance, White, is defined mathematically in figure 2.

$$\text{White} = \frac{\text{Minimum Surface Luminance with all white pixels (P1, P2, P3, P4, P5)}}{\text{Maximum Surface Luminance with all white pixels (P1, P2, P3, P4, P5)}}$$

Note 4. Response time is the time required for the display to transition from white to black (rise time  $T_r$ ) and from black to white (decay or fall time,  $T_f$ ). The industry standard test equipment used is the Autronic-Melcher's Conoscope.

Note 5. CIE (x,y) chromaticity. The x,y value is determined by measuring luminance at each test position 1 through 5, then calculating the average value.

Note 6. The Viewing angle is the angle at which the contrast ratio is greater than 2. For a TFT module, the contrast ratio is greater than 10. The angles are determined for the horizontal or 'x' axis and the vertical or 'y' axis with respect to the 'z' axis, being the LCD surface reference. Also see figure 3.

Note 7. For viewing angle and response time testing, the testing data is based on Autronic-Melcher's BM-7A. For the contrast ratio, surface luminance, luminance uniformity and chromaticity (CIE), the test data is based on the industry's standard SR-3A photo detector.

Note 8. For TFT modules, grey scale reversing occurs in the direction of the panel viewing angle.

Figure 1. Definition of response time

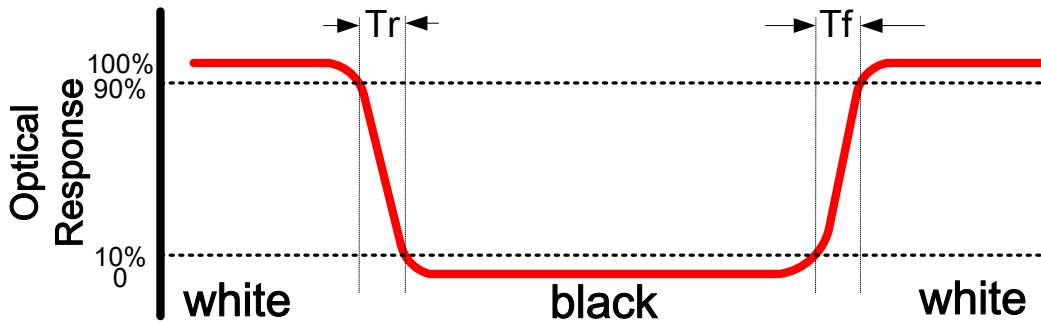

Figure 2. Measuring contrast ratio, surface luminance, luminance uniformity and CIE (chromaticity).

A : 5mm, B : 5mm, H & V : Active area.

Light spot diameter  $\varnothing = 7\text{mm}$ , 500mm distance from the LCD surface to the detector lens.

Measurement instrument is Topcon's luminance meter BM-7.

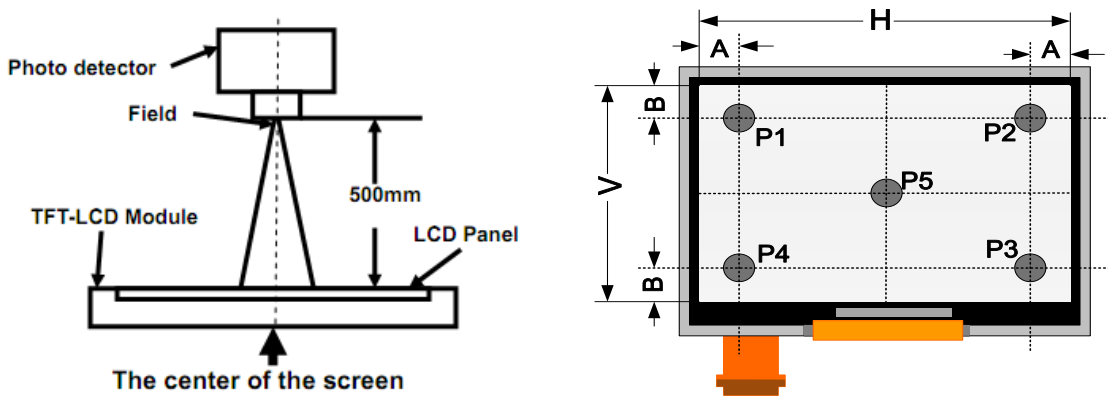
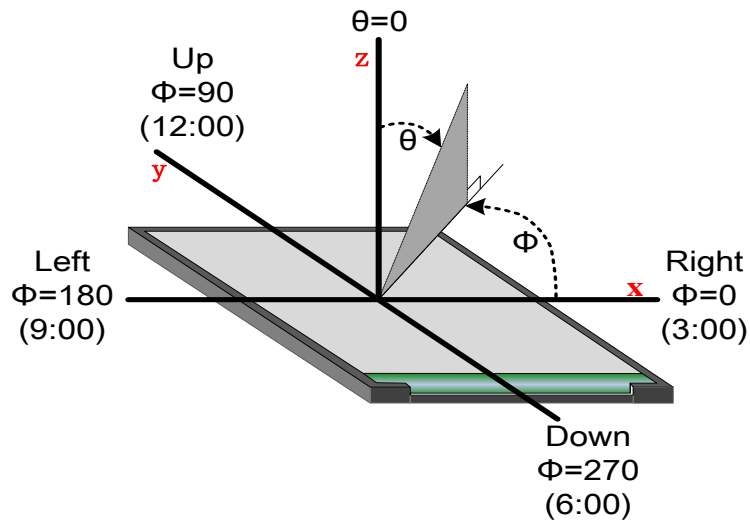

Figure 3. Definition of viewing angle



- INTERFACE DESCRIPTION

No.	Symbol	I/O	Function	Remark
1	VLED-	P	Backlight Cathode	
2	VLED+	P	Backlight Anode	
3	GND	P	Ground	
4	VDD	P	Power source	
5	R0	I	Red data signal	
6	R1	I	Red data signal	
7	R2	I	Red data signal	
8	R3	I	Red data signal	
9	R4	I	Red data signal	
10	R5	I	Red data signal	
11	R6	I	Red data signal	
12	R7	I	Red data signal	
13	G0	I	Green data signal	
14	G1	I	Green data signal	
15	G2	I	Green data signal	
16	G3	I	Green data signal	
17	G4	I	Green data signal	
18	G5	I	Green data signal	
19	G6	I	Green data signal	
20	G7	I	Green data signal	
21	B0	I	Blue data signal	
22	B1	I	Blue data signal	
23	B2	I	Blue data signal	
24	B3	I	Blue data signal	
25	B4	I	Blue data signal	
26	B5	I	Blue data signal	
27	B6	I	Blue data signal	
28	B7	I	Blue data signal	
29	GND	P	Ground	
30	DCLK	I	Clock signal to sample each data	
31	DISP	I	Display on/off signal (this pin is pulled high internally)	
32	HSYNC	I	Horizontal synchronizing signal	
33	VSYNC	I	Vertical synchronizing signal	
34	DE	I	Input data enable control. Internally pulled low.	
35	NC	---	No connection	
36	GND	P	Ground	
37	NC	---	No connection	
38	NC	---	No connection	
39	NC	---	No connection	
40	NC	---	No connection	

I -Input only;

O -Output only;

I/O -Input /output;

P -Power or Ground.

**BLOCK DIAGRAM**

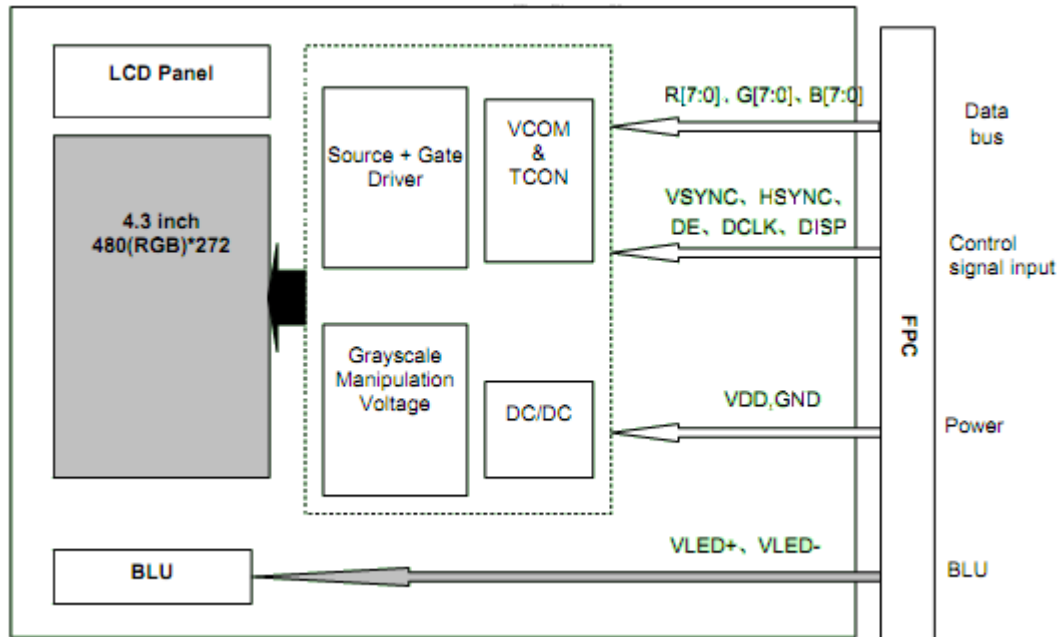

**TIMING CHARACTERISTICS**

**Input Setup Timing Parameter**

VDD=3.3V Ta=25°C

Normal Write Mode

Parameter	Symbol	Min	Typ	Max	Unit	Remark
DCLK Cycle Time	$T_{pw}$	66.7	-	-	ns	
DCLK Pulse High Width	$T_{pwh}$	26.7	-	-	ns	
DCLK Pulse Low Width	$T_{pwl}$	26.7	-	-	ns	
DE Setup Time	$T_{des}$	10	-	-	ns	
DE Hold Time	$T_{deh}$	10	-	-	ns	
HSYNC Setup Time	$T_{hs}$	10	-	-	ns	
HSYNC Hold Time	$T_{hh}$	10	-	-	ns	
VSYNC Setup Time	$T_{vhs}$	10	-	-	ns	
VSYNC Hold Time	$T_{vhh}$	10	-	-	ns	
Data Setup Time	$T_{ds}$	10	-	-	ns	
Data Hold Time	$T_{dh}$	10	-	-	ns	
DISP Setup Time	$T_{diss}$	10	-	-	us	
DISP Hold Time	$T_{dish}$	10	-	-	ms	

**Note 1:**  $t_r=t_f=2ns$ ,  $t_r$  is defined 10% to 90% of signal amplitude.

**Note 2:** For parallel interface, maximum clock frequency is 15MHz.

### Input Setup Timing Diagram

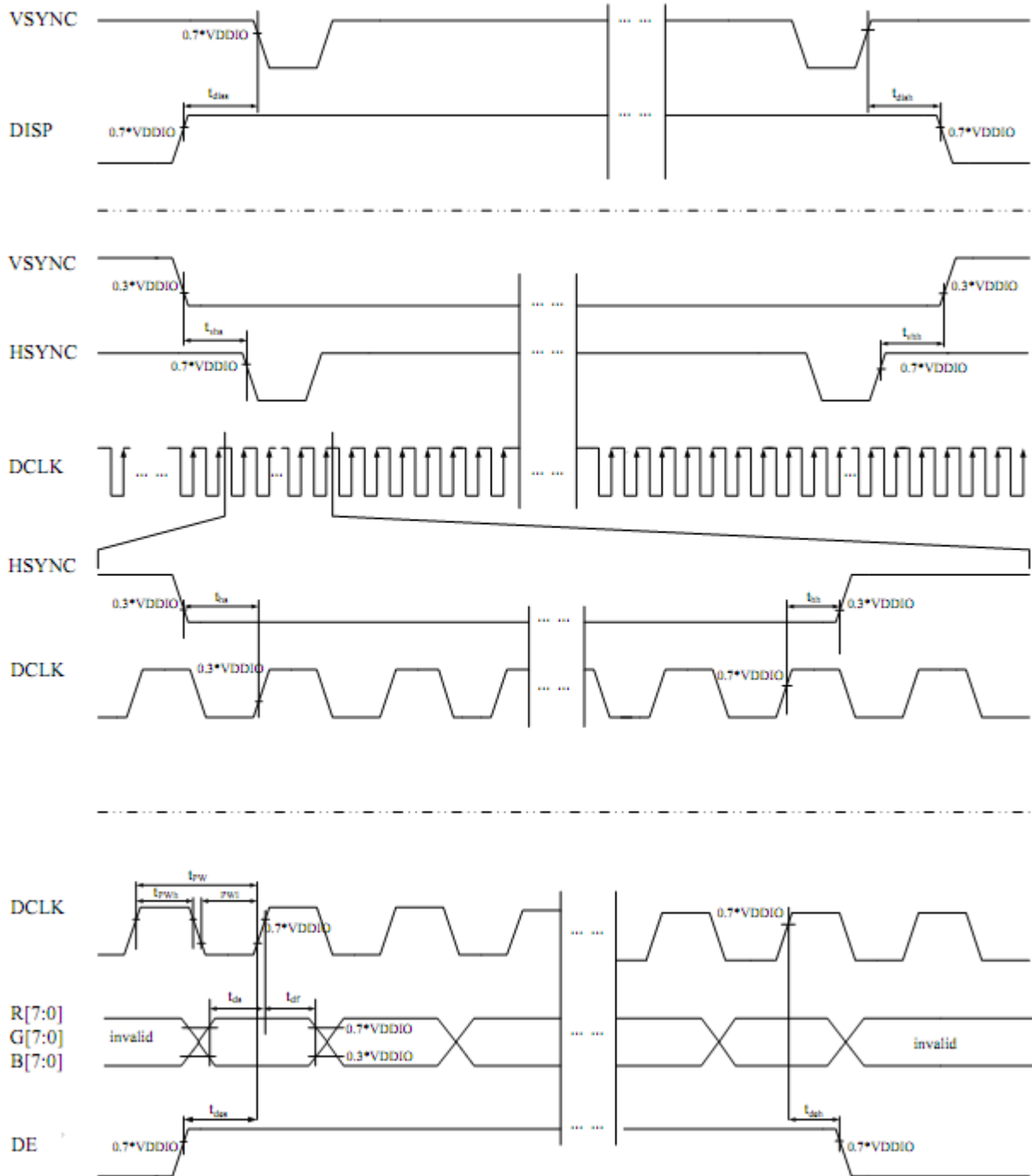

**Data Input Timing Parameter**

Parameter	Symbol	Min	Typ	Max	Unit	Remark
DCLK frequency	$f_{clk}$	--	9	15	MHZ	
HSYNC frequency	$1/t_h$	--	17.14	--	KHz	
VSYNC frequency	$1/t_v$	--	59.94	--	Hz	
Horizontal cycle	$t_h$	525	525	605	DCLK	
Horizontal display period	$t_{hd}$	480			DCLK	
Horizontal pulse width	$t_{hp}$	2	41	41	DCLK	
Horizontal back porch	$t_{hb}$	2	2	41	DCLK	
Horizontal front porch	$t_{hf}$	2	2	82	DCLK	
Vertical cycle	$t_v$	285	286	399	HSYNC	
Vertical display period	$t_{vd}$	272			HSYNC	
Vertical pulse width	$t_{vp}$	1	10	11	HSYNC	
Vertical back porch	$t_{vb}$	1	2	11	HSYNC	
Vertical front porch	$t_{vf}$	1	2	227	HSYNC	

**Note 1:** Unit: CLK=1/  $f_{CLK}$  , H=  $t_h$ ,

**Note 2:** It is necessary to keep  $t_{vp}+t_{vb}=12$  and  $t_{hp}+t_{hb}= 43$  in sync mode. DE mode is unnecessary to keep it.

**Data Input Timing Diagram under SYNC Mode (DE=L)**

SYNC MODE

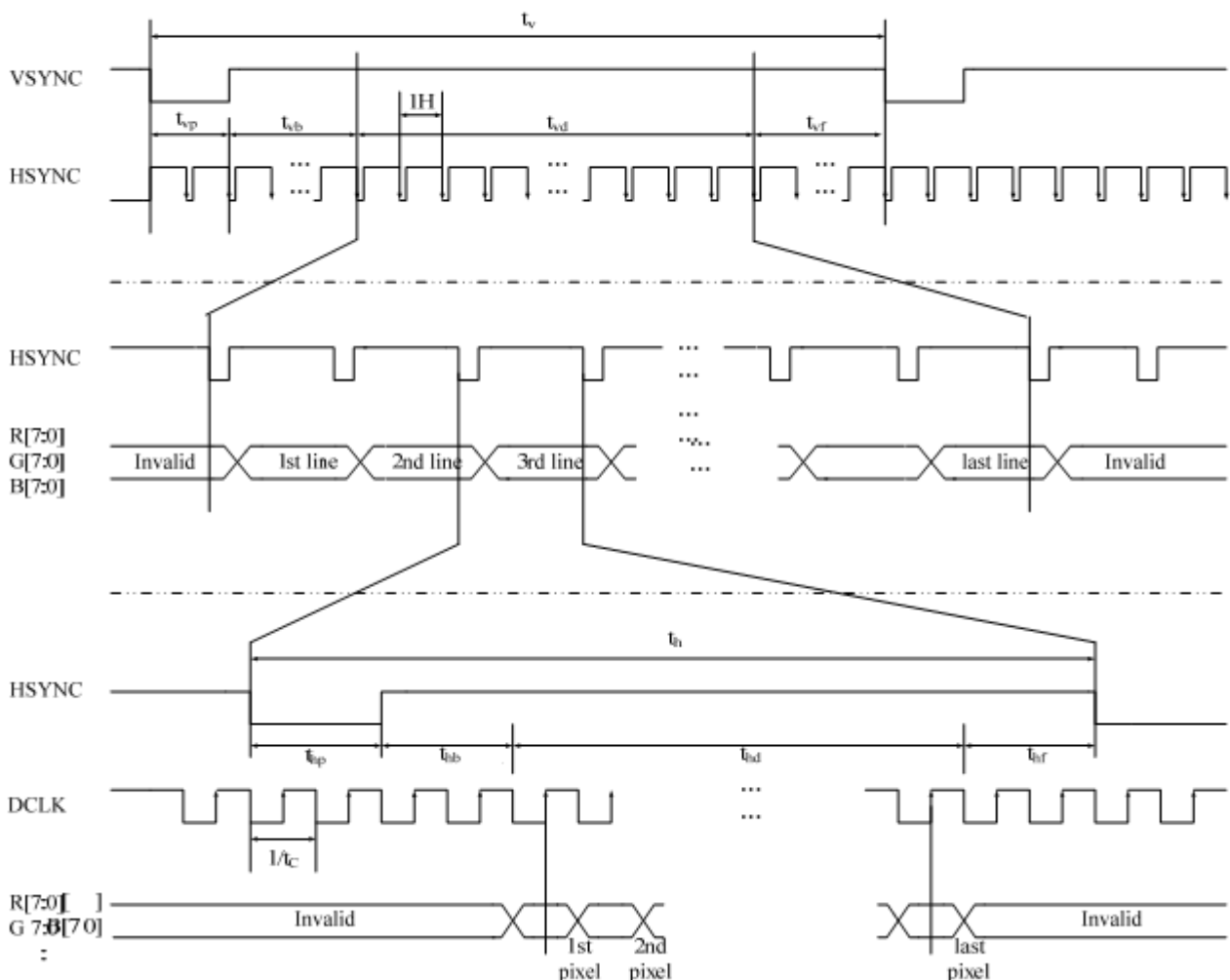

**Data Input Timing Diagram under DE Mode (VSYNC/HSYNC=H)**

DE MODE

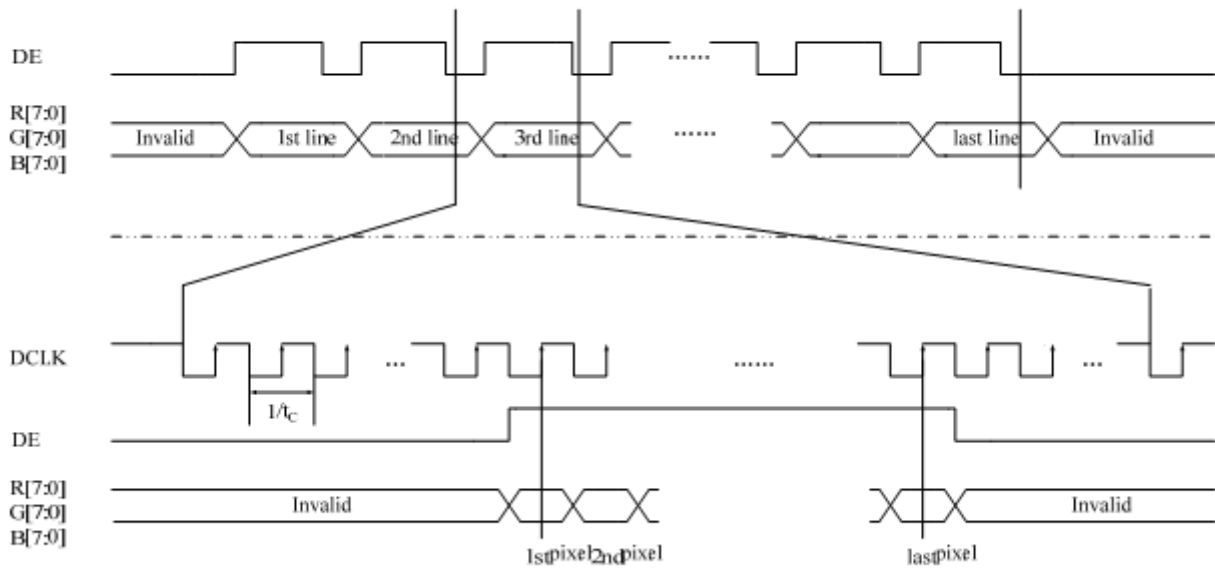

• **POWER ON/OFF SEQUENCE**

**Power ON Sequence**

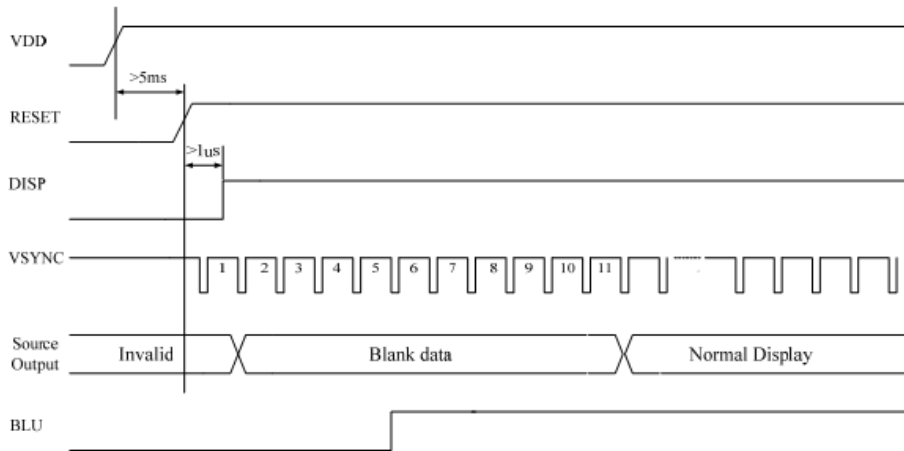

**Power OFF Sequence**

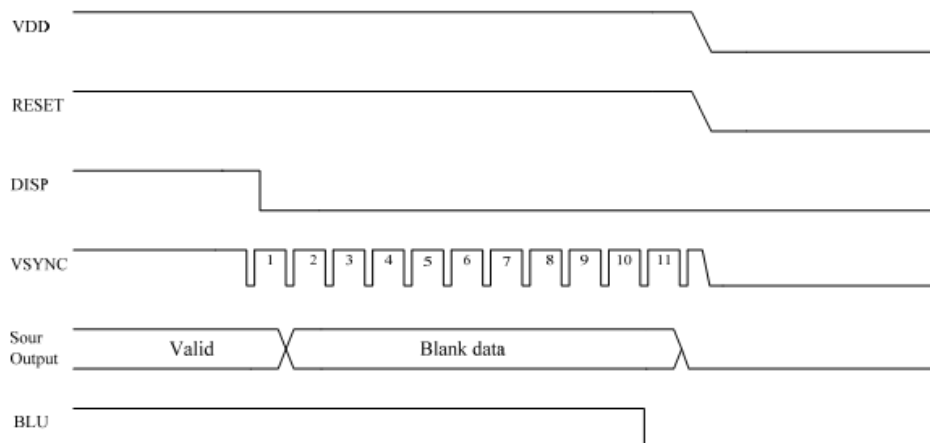

## • RELIABILITY TESTING

NO.	Item	Condition	Criteria
1	High Temperature Operating	70°C +/-2°C, 240Hrs	IEC60068-2-1, GB2423.2
2	Low Temperature Operating	-20°C +/-2°C, 240Hrs	IEC60068-2-1 GB2423.1
3	High Temperature Storage	80°C +/-2°C, 240Hrs	IEC60068-2-1 GB2423.2
4	Low Temperature Storage	-30°C +/-2°C, 240Hrs	IEC60068-2-1 GB2423.2
5	Hi Temperature & High Humidity Operation	50°C, 90%RH max, 240Hrs	IEC60068-2-78 GB/T2423.3
6	Vibration (non operating)	Frequency range:10~55Hz, Stroke:1.5mm Sweep:10Hz~ 55Hz~10Hz2hours for each direction of x.y.z (6 hours for total)	IEC60068-2-6 GB/T2423.10
7	Package Vibration Test	Random Vibration: 0.015GxG/Hz for 5-200Hz, -6dB/Octave from 200-500Hz 2 hours for each direction of X,Y,Z (6 hours for total)	IEC60068-2-34 GB/T2423.11
8	Thermal Shock (non operating)	-30°C to 30min to 80°C, 30min Change time: 5min, 100 cycles	Start with cold temperature, End with high temperature, IEC60068-2- 14:1984,GB2423.22
9	Drop Test (packaged)	Height:80 cm,1 corner, 3 edges, 6 surfaces	IEC60068-2-32 GB/T2423.8
10	Shock (non-operation)	80G 6ms, ±X,±Y,±Z 3 times for each direction	IEC60068-2-27 GB/T2423.5
11	ESD (operation)	C=150pF,R=330Ω, Air:±15Kv, Contact:±8Kv, 10times/terminal	IEC61000-4-2 GB/T17626.2

### Notes:

1. Test samples are applied to one test item.
2. Samples for each test item are 2-10pcs.
3. For humidity testing, a pure water resistance of >10MW should be used.
4. (a) In the case of a malfunction caused by ESD damage, if the LCM returns to normal state after reset, the item is considered to have passed the ESD test.

- (b) It is recommended to use an anti-static blower (ioniser) to reduce the electro-static voltage in the working area.
  - (c) When removing the protection film from the TFT panel, peel off the film slowly (more than 1sec) while blowing the ioniser towards the peeling area to minimize ESD. This will reduce the risk of damaging the electrical circuitry.
5. In operating test, please use the automatic pictures changes test mode or automatic pictures changes on demonstration box.

## • INSPECTION CRITERIA

This specification is designed to be used as the standard acceptance/rejection criteria for normal LCM products.

### 1. Sampling plan.

The sampling plan according to GB/T 2828.1-2003 / ISO2859-16 1999 and ANSI/ASQC Z1.4 1993, normal level 2 and based on:

- Major defect: AQL 0.65
- Minor defect: AQL 1.5

### 2. Inspection condition

- The viewing distance for cosmetic inspection is approximately 30cm with the naked eye, and under an environment of 20-40W light intensity, in all directions, within 45° against a perpendicular line. (Normal temperature 20-25°C and normal humidity 60+/-15 RH.)
- Driving voltage - The Vop value from which the most optimal contrast can be obtained near the specified Vop in the specification (within +/-0.5V of the typical value at 25°C.)

### 3. Definition of inspection zone in LCD.

Zone A : Active Area

Zone B : Viewing Area except Zone A (Zone A + Zone B = Minimum viewing area)

Zone C : Outside Viewing Area (invisible area after assembling customer's product.

Figure 4 inspection zones in an LCD

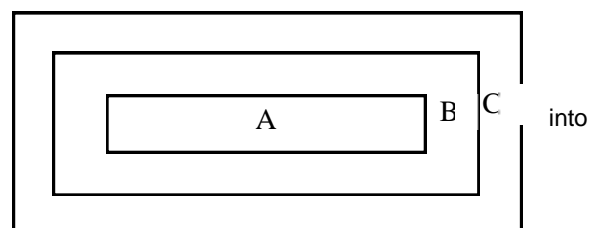

Note: As a general rule visual defects in Zone C are permissible when there is no visual effect once assembled into the customer's product.

• **INSPECTION STANDARD**

• **MAJOR CRITERIA**

Item No	Item to be inspected	Inspection standard	Classification
1	All functional defects	1) No display 2) Display abnormal 3) Missing vertical or horizontal segment 4) Short circuit 5) Backlight not working, flickering and abnormal light	Major
2	Missing	Missing component	
3	Outline dimension	Overall outline dimension beyond the drawing dimension is not allowed	

• **COSMETIC CRITERIA**

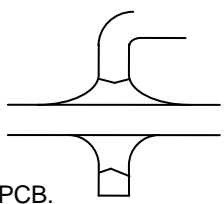
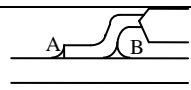
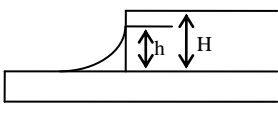
No.	Item	Judgment Criteria	Partition
1	Difference in Spec.	None allowed	Major
2	Pattern peeling	No substrate pattern peeling and floating	Major
3	Soldering defects	No soldering missing No soldering bridge No cold soldering	Major Major Minor
4	Resist flaw on substrate	Invisible copper foil (Ø0.5mm or more) on substrate pattern	Minor
5	Accretion of metallic Foreign matter	No soldering dust No accretion of metallic foreign matters (Not exceed Ø0.2mm)	Minor Minor
6	Stain	No stain to spoil cosmetic badly	Minor
7	Plate discoloring	No plate fading, rusting and discoloring	Minor
8	Solder amount	a. Soldering side of PCB Solder to form a 'Filet' all around the lead. Solder should not hide the lead form perfectly. (too much) b. Components side ( In case of 'Through Hole PCB' )  Solder to reach the Components side of PCB.	Minor
	1. Lead parts		
	2. Flat packages	Either 'toe' (A) or 'heel' (B) of the lead to be covered by 'Filet'. Lead form to be assume over solder. 	
	3. Chips	$(3/2) H \geq h \geq (1/2) H$ 	Minor
9	Solder ball/solder splash	a) The spacing between solder ball and the conductor or solder pad $h \geq 0.13\text{mm}$ . The diameter of the solder ball $d \leq 0.15\text{mm}$ . b) The quantity of solder balls or solder splashes isn't more than 5 in 600mm <sup>2</sup> . c) Solder balls / splashes do not violate minimum electrical clearance d) Solder balls/splashes must be not be able to be dislodged with normal product usage	Minor Minor Major Minor

• COSMETIC CRITERIA (non-operating)

No.	Defect	Judgment Criteria	Classification										
1	Spots	In accordance with Screen Cosmetic Criteria (Operating) No.1.	Minor										
2	Lines	In accordance with Screen Cosmetic Criteria (Operating) No.2.	Minor										
3	Bubbles in polarizer	<table border="1"> <thead> <tr> <th>Size : d mm</th> <th>Acceptable Qty in active area</th> </tr> </thead> <tbody> <tr> <td><math>d \leq 0.3</math></td> <td>Disregard</td> </tr> <tr> <td><math>0.3 &lt; d \leq 1.0</math></td> <td>3</td> </tr> <tr> <td><math>1.0 &lt; d \leq 1.5</math></td> <td>1</td> </tr> <tr> <td><math>1.5 &lt; d</math></td> <td>0</td> </tr> </tbody> </table>	Size : d mm	Acceptable Qty in active area	$d \leq 0.3$	Disregard	$0.3 < d \leq 1.0$	3	$1.0 < d \leq 1.5$	1	$1.5 < d$	0	Minor
Size : d mm	Acceptable Qty in active area												
$d \leq 0.3$	Disregard												
$0.3 < d \leq 1.0$	3												
$1.0 < d \leq 1.5$	1												
$1.5 < d$	0												
4	Scratch	In accordance with spots and lines operating cosmetic criteria. When the light reflects on the panel surface, the scratches are not to be remarkable.	Minor										
5	Allowable density	Above defects should be separated more than 30mm each other.	Minor										
6	Coloration	Not to be noticeable coloration in the viewing area of the LCD panels. Back-lit type should be judged with back-lit on state only.	Minor										
7	Contamination	Not to be noticeable.	Minor										

• COSMETIC CRITERIA (operating)

No.	Defect	Judgment Criteria	Classification																				
1	Spots	<p>A) Clear</p> <table border="1"> <thead> <tr> <th>Size : d mm</th> <th>Acceptable Qty in active area</th> </tr> </thead> <tbody> <tr> <td><math>d \leq 0.1</math></td> <td>Disregard</td> </tr> <tr> <td><math>0.1 &lt; d \leq 0.2</math></td> <td>6</td> </tr> <tr> <td><math>0.2 &lt; d \leq 0.3</math></td> <td>2</td> </tr> <tr> <td><math>0.3 &lt; d</math></td> <td>0</td> </tr> </tbody> </table> <p>Note : Including pin holes and defective dots which must be within one pixel size.</p> <p>B) Unclear</p> <table border="1"> <thead> <tr> <th>Size : d mm</th> <th>Acceptable Qty in active area</th> </tr> </thead> <tbody> <tr> <td><math>d \leq 0.2</math></td> <td>Disregard</td> </tr> <tr> <td><math>0.2 &lt; d \leq 0.5</math></td> <td>6</td> </tr> <tr> <td><math>0.5 &lt; d \leq 0.7</math></td> <td>2</td> </tr> <tr> <td><math>0.7 &lt; d</math></td> <td>0</td> </tr> </tbody> </table>	Size : d mm	Acceptable Qty in active area	$d \leq 0.1$	Disregard	$0.1 < d \leq 0.2$	6	$0.2 < d \leq 0.3$	2	$0.3 < d$	0	Size : d mm	Acceptable Qty in active area	$d \leq 0.2$	Disregard	$0.2 < d \leq 0.5$	6	$0.5 < d \leq 0.7$	2	$0.7 < d$	0	Minor
Size : d mm	Acceptable Qty in active area																						
$d \leq 0.1$	Disregard																						
$0.1 < d \leq 0.2$	6																						
$0.2 < d \leq 0.3$	2																						
$0.3 < d$	0																						
Size : d mm	Acceptable Qty in active area																						
$d \leq 0.2$	Disregard																						
$0.2 < d \leq 0.5$	6																						
$0.5 < d \leq 0.7$	2																						
$0.7 < d$	0																						
2	Lines	<p>A) Clear</p> <p>Note : ( ) - Acceptable Qty in active area L - Length (mm) W - Width (mm) <math>\infty</math> - Disregard</p> <p>B) Unclear</p>	Minor																				

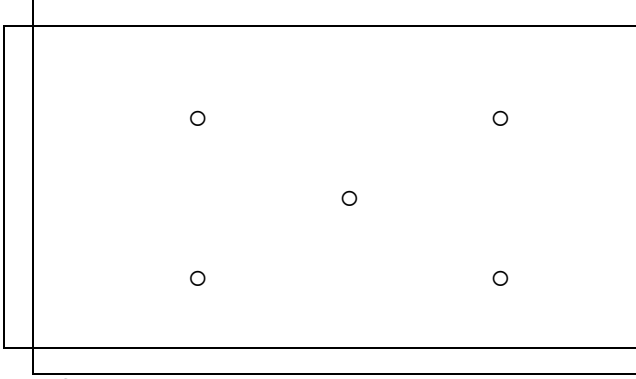
3	Rubbing line	Not to be noticeable.	
4	Allowable density	Above defects should be separated more than 10mm each other.	Minor
5	Rainbow	Not to be noticeable.	Minor
6	Dot size	To be 95% ~ 105% of the dot size (Typ.) in drawing. Partial defects of each dot (ex. pin-hole) should be treated as 'spot'. (see Screen Cosmetic Criteria (Operating) No.1)	Minor
7	Uneven brightness (only back-lit type module)	Uneven brightness must be $B_{MAX} / B_{MIN} \leq 2$ - $B_{MAX}$ : Max. value by measure in 5 points - $B_{MIN}$ : Min. value by measure in 5 points Divide active area into 4 vertically and horizontally. Measure 5 points shown in the following figure.  ○ : Measuring points	Minor

**Note :**

- (1) Size :  $d = (\text{long length} + \text{short length}) / 2$
- (2) The limit samples for each item have priority.
- (3) Complex defects are defined item by item, but if the number of defects are defined in above table, the total number should not exceed 10.
- (4) In case of 'concentration', even the spots or the lines of 'disregarded' size should not allowed.

Following three situations should be treated as 'concentration'.

- 7 or over defects in circle of  $\varnothing 5\text{mm}$ .
- 10 or over defects in circle of  $\varnothing 10\text{mm}$ .
- 20 or over defects in circle of  $\varnothing 20\text{mm}$ .

## ● PRECAUTIONS FOR USING LCD MODULES

### ● HANDLING PRECAUTIONS

- (1) The display panel is made of glass. Do not subject it to a mechanical shock by dropping it or impact.
- (2) If the display panel is damaged and the liquid crystal substance leaks out, be sure not to get any in your mouth. If the substance contacts your skin or clothes, wash it off using soap and water.
- (3) Do not apply excessive force to the display surface or the adjoining areas since this may cause the color tone to vary.
- (4) The polarizer covering the display surface of the LCD module is soft and easily scratched. Handle this polarizer carefully.
- (5) If the display surface becomes contaminated, breathe on the surface and gently wipe it with a soft dry cloth. If it is heavily contaminated, moisten cloth with one of the following solvents:
  - Isopropyl alcohol
  - Ethyl alcohol
- (6) Solvents other than those above-mentioned may damage the polarizer. Especially, do not use the following.

- Water
- Ketone
- Aromatic solvents

(7) Exercise care to minimize corrosion of the electrode. Water droplets, moisture condensation or current flow in a high-humidity environment, accelerate corrosion of the electrodes.

(8) Install the LCD Module by using the mounting holes. When mounting the LCD module ensure it is free of twisting, warping or distortion.

(9) Do not attempt to disassemble the LCD module.

(10) NC terminal should be open. Do not connect anything.

(11) If the logic circuit power is off, do not apply the input signals.

(12) To prevent destruction of the elements by static electricity, be careful to maintain an optimum work environment.

- Be sure to ground the body when handling the LCD modules.
- Tools required for assembling, such as soldering irons, must be properly grounded.
- To reduce the amount of static electricity generated, do not conduct assembling and other work under dry conditions.
- The LCD module is coated with a film to protect the display surface. Exercise care when peeling off this protective film since static electricity may be generated.

## • STORAGE PRECAUTIONS

When storing the LCD modules, the following precaution is necessary.

(1) Store them in a sealed polyethylene bag. If properly sealed, there is no need for the dessicant.

(2) Store them in a dark place. Do not expose to sunlight or fluorescent light, keep the temperature between 0°C and 35°C, and keep the relative humidity between 40%RH and 60%RH.

(3) The polarizer surface should not come in contact with any other objects. (We advise you to store them in the anti-static electricity container in which they were shipped.

## • OTHERS

Liquid crystals solidify under low temperature (below the storage temperature range) leading to defective orientation or the generation of air bubbles (black or white). Air bubbles may also be generated if the module is subject to a low temperature.

If the LCD modules have been operating for a long time showing the same display patterns, the display patterns may remain on the screen as ghost images and a slight contrast irregularity may also appear. A normal operating status can be regained by suspending use for some time. It should be noted that this phenomenon does not adversely affect performance reliability.

To minimize the performance degradation of the LCD modules resulting from destruction caused by static electricity etc., exercise care to avoid holding the following sections when handling the modules.

- Exposed area of the printed circuit board.
- Terminal electrode sections.

## • PRECAUTIONS FOR SOLDERING THE LCM

	Manual Soldering	Machine Drag Soldering	Machine Pre-soldering
Non ROHS Product	290°C ~ 350°C Speed : 3 ~ 5 mm/s	330°C ~ 350°C Speed : 4 ~ 8mm/s	300°C ~ 330°C Time : 3 ~ 6S Pressure : 0.8 to 1.2Mpa
RoHS Product	340°C ~ 370°C Time : 3 ~ 5S.	350°C ~ 370°C Time : 4 ~ 8 mm/S.	330°C ~ 360°C Time : 3 ~ 6S. Pressure : 0.8 ~ 1.2Mpa.

- (1) If solder flux is used, be sure to remove any remaining flux after finishing the soldering process. (This does not apply in the case of a non-halogen type of flux.) It is recommended that your protect the LCD surface with a cover during the soldering process to prevent any damage due to

the flux sparks.

- (2) When soldering a backlight panel and PCB, the panel and PCB should not be detached more than 3 times. The temperature determines this number and time conditions as mentioned in the above table, although there may be some variance depending on the actual temperature of the soldering iron.
- (3) When removing a backlight panel from the PCB, ensure the solder has completely melted, otherwise the solder pads on the backlight panel and/or PCB may be damaged.

#### • OPERATION CAUTION

(1) It is recommended to drive LCDs within their specified voltage limit since the higher voltage than the upper limit shortens the LCD life. An electrochemical reaction due to direct current causes the LCD to deteriorate. Therefore, avoid the use of direct current drive.

(2) Response time will be extremely delayed at lower temperatures than the operating temperature range. At higher temperatures LCD's will experience a dark color. However those phenomena do not mean a malfunction or the LCD's. Once the LCDs are returned to the specified operating temperature range, the response time and colouration should return to the normal state.

(3) If the display area is physically pressed hard during it's operation, some pixels may be abnormally displayed, but should return to their normal condition after resetting the LCM.

(4) Moisture sitting on the LCM terminals is a cause for an electro-chemical reaction resulting in a terminal open circuit. Usage under the relative condition of 40°C, 50%RH or less is therefore required.

#### • SAFETY

- (1) It is recommended to crush any damaged or unnecessary LCDs into pieces and wash off the liquid crystal by using solvents such as acetone and ethanol, which should then be burned up later.
- (2) When any liquid crystal has leaked out of a damaged glass cell and comes in contact with skin, please wash it off well with soap and water.

#### • WARRANTY

Unless otherwise agreed between Logic Technologies Ltd and the customer, Logic Technologies will replace or repair any of its products that are found to be functionally defective when inspected in accordance with Logic Technologies' acceptance criteria (copies available upon request) for a period of one year from date of shipment. Cosmetic/visual defects must be returned to Logic Technologies within 90 days of shipment. Confirmation of such date shall be based on freight documents. The warranty liability of Logic Technologies is limited to the repair and/or replacement on the terms set forth above. Logic Technologies will not be responsible for any subsequent or consequential losses and/or events.

#### • RETURNING PRODUCTS UNDER WARRANTY

No warranty can be granted if the precautions stated above have been disregarded. The typical examples of violations are:

- Broken LCD glass.
- PCB eyelet's damaged or modified.
- PCB conductors damaged.
- Circuit modified in any way, including addition of components.
- PCB tampered with by grinding, engraving or painting varnish.
- Soldering to or modifying the bezel in any manner.

Product repairs will be invoiced to the customer upon mutual agreement. Products must be returned with sufficient description of the failures and/or defects. Any connectors or cable installed by the customer must be removed completely without damaging the PCB eyelet's, conductors and terminals.